

Instruction Manual

**PiezoBeam®
Accelerometers**

**Type 8640A...
 8640A...T
 8688A...
 8688A...T**



Instruction Manual

PiezoBeam® Accelerometers

Types 8640A...
8640A...T
8688A...
8688A...T

Forward

This instruction manual refers to PiezoBeam Accelerometer Types 8640A..., and Type 8688A... .

Information in this document is subject to change without notice. Kistler reserves the right to change or improve its products and make changes in the content without obligation to notify any person or organization of such changes or improvements.

© 2010, Kistler Group. All rights reserved.

Kistler Group
Eulachstrasse 22
8408 Winterthur
Switzerland
Tel. +41 52 224 11 11
Fax +41 52 224 14 14
info@kistler.com
www.kistler.com

Content

1. Introduction	5
2. Important Guidelines	6
2.1 For Your Safety	6
2.2 Precautions	6
2.3 Using This Manual	7
3. General Information.....	8
3.1 PiezoBeam Accelerometer Types	8
3.2 Supplied Items.....	8
4. Technical Information, Functional Description	9
4.1 Introduction	9
4.2 Principles of Operation.....	9
4.3 Features	10
4.4 Technical Discussion.....	11
4.5 Time Constant.....	12
4.5.1 Supply Current Effects.....	14
4.5.2 Temperature Effects	16
4.5.3 Overload Recovery.....	16
5. Installation.....	17
5.1 Mounting Configuration by Type.....	17
5.2 Preferred Installation Techniques.....	18
5.3 Surface Preparation	19
5.4 Mounting.....	19
5.4.1 Adhesive Mounting.....	19
5.4.2 Stud Mounting, Type 8640A...T	21
5.4.3 Stud Mounting, Type 8688A...T	21
5.4.4 Magnetic Mounting, Types 8640A...T, 8688A...T	22
5.5 Electrical Installation	22
5.6 Cables	23
5.6.1 Single Axis Accelerometer Cable Requirements	23
5.6.2 Triaxial Accelerometer Cable Requirements.....	23
5.6.3 Cable Routing	25
6. Calibration and Maintenance	26
6.1 Calibration	26
6.2 Maintenance	27
6.2.1 Care and Cleaning.....	27
6.2.2 Service and Repair.....	27
7. Warranty.....	28

Total pages 28

1. Introduction

By choosing Kistler PiezoBeam accelerometers you have opted for an instrument distinguished by precision, long life and technical innovation. Please read these instructions carefully before installing and operating these instruments.

Kistler offers a wide selection of measuring instruments and comprehensive systems including:

- Quartz sensors for force, pressure, acceleration, shock, vibration and strain.
- Associated signal conditioners and accessories.
- Piezoresistive pressure sensors and transmitters with associated amplifiers.

Kistler can also provide entire systems for special purposes in the automotive industry, plastics processing, and biomechanics. Our general catalog provides information on Kistler's products and services. Detailed technical data sheets are available on most products offered.

Worldwide customer service is at your disposal should you have any questions regarding this or other Kistler products. Information on your specific application is also available from Kistler.

2. Important Guidelines

To ensure your personal safety, please observe the safety guidelines in this section.

2.1 For Your Safety

- Carefully follow the installation information contained in section 5 of this manual.
- Do not drop the instrument.
- Store in the case provided and in a clean, dry environment.
- Power the instrument in accordance with the instructions in section 4.5.1 of this manual.

2.2 Precautions

Kistler's sensors are thoroughly tested before leaving the factory. To maintain safe and reliable operation, it is important to follow the instructions herein.

- Do not mount accelerometers on high voltage surfaces.
- Keep cable clear of power lines and open machinery.
- Never operate or store the unit beyond the specified temperature range.
- Do not exceed the maximum specified current.
- Never exceed the maximum specified voltage.
- Follow the instructions for mounting. Do not over tighten.
- Do not expose the unit to excessive shock, i.e., by using a hammer or dropping the unit.
- When not in use, store the accelerometer in the container supplied. Always store in a clean, dry area.
- Keep the connector clean and covered when not in use or store the unit beyond the specified temperature range.

2.3 Using This Manual

Information contained herein includes a technical description, installation and operating instructions, powering and considerations for cable length.

It is recommended that the entire manual be read prior to installation and operation of PiezoBeam accelerometers. The user who has prior experience with low impedance voltage mode accelerometers may want to confine reading to particular sections of interest.

We have attempted to arrange these instructions in a manner that allows for easy location of topics of interest. Your Kistler representative is also available to assist with any questions.

Information contained herein may be subject to change.

3. General Information

3.1 PiezoBeam Accelerometer Types

This manual is applicable to the next generation PiezoBeam Accelerometers listed on the title page. Please see the specifications in the enclosed data sheet on the specific accelerometer ordered

Types 8640A(X)T and 8688A(X)T are variants of the standard version incorporating the "Smart Sensor" design. Smart Sensor operation as defined by IEEE P1451.4 permits a Mixed Mode Protocol, where the sensors electronics stores key characteristic data in digital format while retaining the primary analog operational performance. Industry refers to the stored information as a data sheet ; hence the acronym, TEDS (Transducer Electronic Data Sheet). Viewing an accelerometers data sheet requires a Interface/Coupler such as Kistler's Model 5134B. The Interface/Coupler provides negative current excitation (reverse polarity) altering the operating mode of the PiezoSmart® Sensor and allowing the program editor software to read or add information contained in the memory chip.

Kistler publication K20.302 "IEEE P 1451.4: Measurement With Smart Transducers" includes information on the IEEE Standard 1451.4, the operating manner of smart sensors, a detail review of the TEDS Editor and data sheet content.

3.2 Supplied Items

Each accelerometer is supplied with a quick locking adhesive mount clip (Types 8000M156 and 8000M155) and Ground Isolated Adhesive Mounting Base (Types 8000M156 and 8000M155) for Types 8640A...T and 8688A...T respectively. Petro Wax is also provided.

4. Technical Information, Functional Description

4.1 Introduction

This manual describes installation, calibration, operating and maintenance procedure for the Kistler PiezoBeam accelerometer product line. These accelerometers excel with their low profile, low weight and high sensitivity. They are especially well suited for measuring vibrations and oscillations in mechanical Structures. The PiezoBeam accelerometer Series have low impedance output and are fully compatible with Piezotron® sensors. Hence the PiezoBeam's are compatible with all Piezotron and ICP compatible signal conditioning equipment.

4.2 Principles of Operation

Acceleration forces applied perpendicular to the PiezoBeam's mounting base are converted by a bimorph flexure element into proportional charge signals. These charge signals are internally converted by a miniaturized hybrid charge amplifier into high level, low impedance voltage output signals. The power and signal de-coupling are provided by the same signal conditioners, Type 5100 series couplers or a dual mode charge amplifier, as with the Piezotron type sensors. A constant current, regulated source voltage powers the unit. An 11 volt bias voltage is generated and the dynamic sensor signal is superimposed on this bias voltage. The coupler removes the bias voltage and outputs the time varying voltage, which is directly proportional to the acceleration. Cable length and capacitance have little or no effect on the calibration of the accelerometers and can typically be ignored.

4.3 Features

The uniqueness of this family of sensors is the combination of the following excellent characteristics in a single package:

- Low mass
- High sensitivity
- Excellent resolution
- Low base strain sensitivity
- Wide frequency range
- Superior environmental isolation

A simplified cross section of the design is shown in Fig 1. Basically, two cantilever beam bimorph elements produce a significant charge output which is coupled with elaborate internal signal conditioning yielding a high level, low threshold sensor. A light weight, high strength aluminum alloy housing is hard anodized to provide a durable, ground isolated mounting surface. The Sensing element is well isolated from potential external mechanical and thermal inputs using a patented element design.

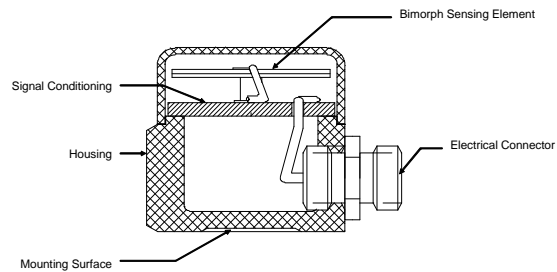

Figure 1: Simplified PiezoBeam cross section

Type	Description
8640A(X)	Single Axis Accelerometer, for stud, magnetic, adhesive or wax mounting
8688A(X)	Triaxial Accelerometer, for stud, magnetic, adhesive or wax mounting
8640A(X)T	TEDS Single Axis Accelerometer, for stud, magnetic, adhesive or wax mounting
8688A(X)T	TEDS Triaxial Accelerometer, for stud, magnetic, adhesive or wax mounting

Table 1: Brief description by Type

Note: The range of each accelerometer is included in each type number, e.g. 8640A5 has a 5 g range for full-scale output and 8640A50 has a 50 g range for full-scale.

4.4 Technical Discussion

Early piezoelectric sensors required the user to know all cable and amplifier capacitances to be able to measure the precise amplitude of a signal. The invention of the charge amplifier by Walter Kistler eliminated the requirement of known cable and amplifier capacitances but did not solve the requirements for an ultra high impedance at the amplifier input. With the advent of modern solid state technology came the means of converting the high impedance charge output of a piezoelectric sensor to an easier to use low impedance voltage output. In 1967, Kistler Instruments received a patent for an impedance converter circuit.

Modern vibration instrumentation includes an amplifier within the sensor. A means of supplying electrical power to the sensor is necessary. The PiezoBeam uses a common two-wire cable for both the power and output signal. Normal coaxial cable is used with one side referenced to ground. The sensor amplifier is powered by a constant current source, typically 4 mA, although in special cases this may be set as low as 0.5 mA or as high as 18 mA. The amplifier within the sensor will produce a nominal bias voltage of 11 Volts. As the sensor is exposed to stimuli, the instantaneous voltage at the sensor output will vary.

The low-impedance coupler in its simplest form is a constant current source and a R-C network to block the 11 Volt DC component and pass only the AC signal. The signal at this point has a source impedance which is in the range of 10 to 500 Ohms and can easily drive auxiliary equipment without fear of accuracy degradation.

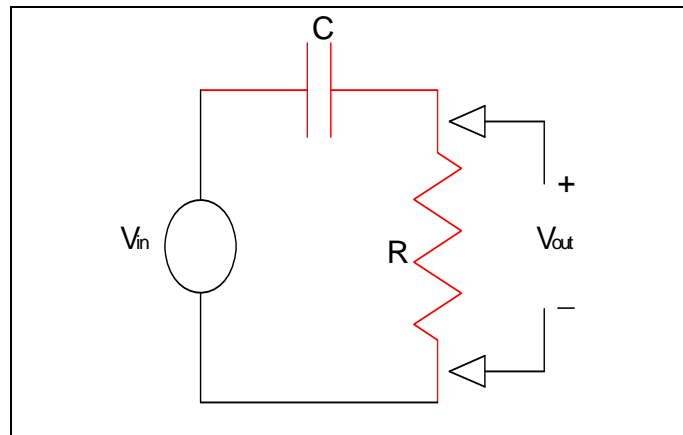

Figure 2: RC filter schematic (High-Pass)

4.5 Time Constant

The resistor-capacitor network shown in Fig. 2 is representative of the piezoelectric sensor and, with a few minor changes, the coupler circuit. In the frequency domain, the response is that of a high-pass filter. At DC, the network blocks any signal; as the frequency increases, the output amplitude increases until the input and output are identical. A plot of the amplitude and phase versus frequency is shown in Fig. 3. Note that at very low frequencies, the output is zero.

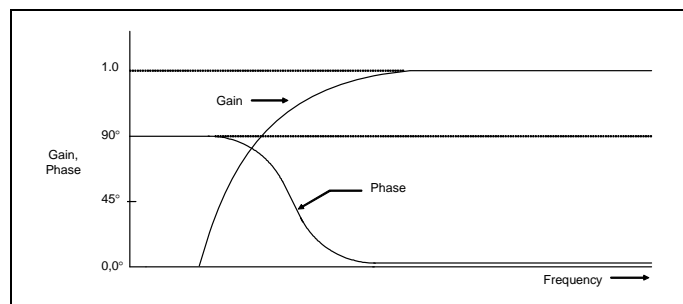

Figure 3: High-Pass filter output vs. frequency

Because of the high-pass filter response, the piezoelectric sensor does not produce DC information. Low frequency signals are only valid if the frequency is within the pass-band of the filter. As we shall see, the pass-band of this filter, defined by the cutoff frequency or “3 dB point” is directly related to the RC time constant.

Consider the network in Fig. 2. If the exciting signal is a step function. initially, the output will follow the step input and produce a step which is equal to the input step. The capacitor will block the DC which is now present on the input. Through the resistor, the capacitor will discharge and the output will decay to zero. Fig. 4 shows the expected output for a step input.

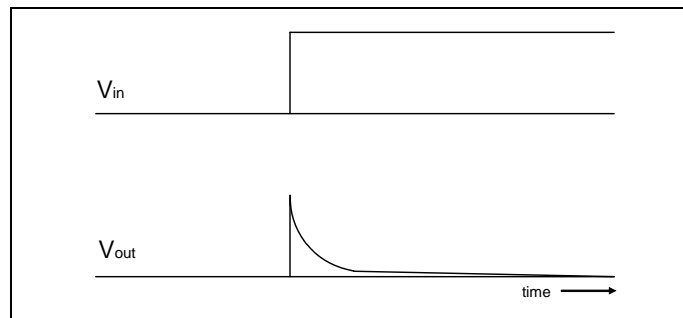

Figure 4: Output for a step input

The exact voltage across the capacitor with respect to time may be found by applying analysis techniques. Classical circuit analysis techniques will yield a differential equation for this network which has a solution given as:

$$V_{in} = V_{out} (e^{-t/RC})$$

The derivation of the differential equation and solution for this network is often given as an introduction to circuit analysis and will not be repeated here. Note that the solution has, at time equal to zero, a magnitude equal to V_{in} . This agrees with our earlier assumption. At some large value of time the exponential term approaches the value of one and the function as a whole approaches zero amplitude. The quantity RC in the denominator of the exponential e power is often replaced with the value τ . τ (tau) is what is commonly called the time constant of the network.

The time constant of a network is useful when working in the time domain. Often it is more convenient to think of response as a function of frequency. Again turning to classical circuit analysis we find another solution for the sinusoidal steady state where relative amplitude is a function of input frequency. Here we assume that the input frequency is a single frequency sinusoid which has been present at the input for a long time.

The amplitude is given by:

$$\frac{V_{out}}{V_{in}} = K(\omega) = \frac{\omega RC}{\sqrt{1 + (\omega RC)^2}} = K(f) = \frac{2\pi f RC}{\sqrt{1 + (2\pi f RC)^2}}$$

Here RC is the product of the resistor in Ohms and the capacitor in Farads. Again, the product RC is sometimes replaced with the value τ . The value ω is the angular frequency in radians per second which is equal to $2\pi f$, where f is the frequency in Hertz.

Another important feature of this network is the phase angle between the input and output sinusoid. The phase angle from classical circuit analysis is known to be 90° in the stop band, 45° at the -3 dB frequency and approaching zero at high frequencies (see Fig. 3). The phase expressed in degrees is:

$$\Theta = \tan^{-1} \frac{1}{\omega RC} = \tan^{-1} \frac{1}{2\pi f RC}$$

Note: The specifications given in this manual are for the PiezoBeam accelerometer. The time constant of the connected signal conditioner (i.e. coupler or dual mode charge amplifier) must be taken into account when determining the system's frequency response. A system's time constant may be approximated by taking the product of the time constants for the accelerometer and signal conditioner, then dividing by their sum.

4.5.1 Supply Current Effects

An amplifier may be defined as a device which adds power to a signal, in contrast to a transformer which can boost voltage at the expense of current or vice versa. In order to operate, an amplifier must have a source of power. This is a practical expression of the classic physics law of conservation of energy. In a low impedance system this power is in the form of a constant 4 mA current.

When a PiezoBeam or any low impedance accelerometer is at rest, the entire 4 mA current supply is consumed by the amplifier within the sensor. In the presence of a dynamic signal, a portion of this current is actually used to drive the output cable. The output cable, in addition to being a conductor, is also a capacitive shunt to ground.

Typically, each foot of output cable is equal to 30 pF capacitance. The small capacitance of a foot of cable might appear insignificant at first but consider the consequences of a long length of cable. The PiezoBeam amplifier must have at least 2 mA to operate properly. Below this level, the amplifier becomes non functional. With a 4 mA supply current, 2 mA is available to drive the cable and 2 mA is required to operate the PiezoBeam without distortion. The voltage-current relationship of a capacitor is:

$$I = C \frac{dV}{dt}$$

dV/dt is the slew rate or the maximum rate of change of voltage across the capacitor for a given current.

When the slew rate is not exceeded, the excess current is dissipated in the amplifier. When the output voltage attempts to change at a high rate, the excess current is used to drive the cable. If the slew rate is too high, current will no longer be available to operate the amplifier and invalid signals will result. Substituting actual numbers:

$$V = \sin \omega t \quad \frac{dV}{dt} = \frac{d}{dt} = \sin \omega t = \omega \cos \omega t$$

For example, for a 2 kHz frequency, the maximum slew rate is 12,600 Volts per second. The available current for cable driving (with 4 mA supply) equals 2 mA, since 2 mA is the minimum for the PiezoBeam charge amplifier to operate. Thus, the total cable capacitance is equal to:

$$C = \frac{I}{\left| \frac{dV}{dt} \right|_{\max}} = \frac{0.002}{12,600} = 159nF$$

This is equivalent to 5,290 feet (1.6 km) of cable, approximately one mile.

For most applications, the 4 mA current is sufficient for the PiezoBeam accelerometers. For measuring high frequencies and high amplitudes, special attention must be paid to slew rate and current when operating long cables. All units are capable of operation up to 18 mA supply current. Some power supply / couplers offer adjustable constant current sources for very high frequency, high amplitude applications. However, since PiezoBeam's are mechanically limited to no more than 5 kHz, the 4 mA constant current supply is usually adequate.

4.5.2 Temperature Effects

PiezoBeam accelerometers or any accelerometers, are sensitive to temperature transients. A patented seismic element is used to minimize the effects of temperature transients (reference World Patent WO/2007/062532, European Patent 2006790940, U.S. Patent 12088325).

The PiezoBeam accelerometer, like most other precision instruments, is tested and calibrated at a known temperature. Sensitivity is normalized at 25°C. When the unit is operated at a significantly different temperature, there may be an error due to sensitivity shifts. Individual components were carefully specified so that the overall shift with temperature is as small as possible.

There are components inside the PiezoBeam accelerometer which automatically compensate for temperature effects; however, the match isn't always perfect. Over the operating temperature range of the unit the overall shift is small with the magnitude specified as the Sensitivity Temperature Coefficient on the Data Sheet.

4.5.3 Overload Recovery

Whenever the amplifier is driven by a signal exceeding the normal operating range, certain Components become non-operational. During this non-operational state, the amplifier components are protected from overload damage. The output bias will go either to an open or shorted state and time must be allowed to return to an operating state. The amount of time required for recovery from an overload depends on a number of factors. Important for overload recovery is the size of the overload. But, most important is the time constant of the amplifier. Time constant, recovery time and warm-up time are proportional to each other. Figure 5 shows a time plot of a typical overload and recovery sequence.

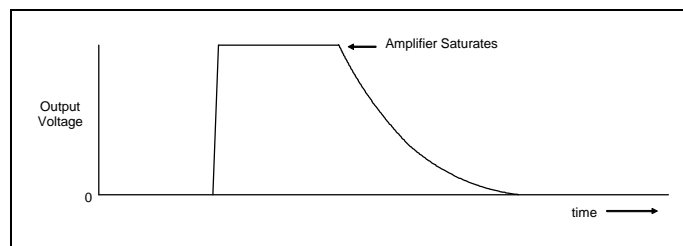

Figure 5: Typical overload and recovery sequence

5. Installation

This section defines mounting requirements and provides installation procedures for PiezoBeam accelerometers. Those accelerometers suited for adhesive mounting have a large mounting area to weight ratio. The typical application for these high sensitivity sensors is acquiring information from low level, relatively low frequency motions. These conditions significantly relax the mounting requirements that are typical to other (large amplitude, high frequency) accelerometer test situations. In most PiezoBeam test situations a minimal, uniform layer of Petro Wax provides a sufficient mounting attachment.

5.1 Mounting Configuration by Type

A brief description and mounting illustration for each configuration is given below.

The cube shape configuration of the 8640A...T single axis accelerometer allows for the sensor to be attached to the test surface using any available side with wax, adhesive, tape or the off-ground mounting clip. The primary mounting surface also has a 5-40 UNF threaded hole which is compatible with off-ground screw-on adhesive mounting base accessory in or a magnetic mounting accessory. The frequency response is unaffected for the specified ranges when the adhesive mounting adapter or magnetic mounting adapter is used. When the off-ground mounting clip is used, the upper frequency response without grease is 1 kHz ($\pm 5\%$) for all ranges, 3 kHz ($\pm 5\%$) (with grease for 5 g and 10 g ranges) and 4 kHz ($\pm 5\%$) (with grease for the 50 g Range). Reliable and accurate measurements require that the mounting surface be clean and flat. This operating instruction manual provides detailed information regarding mounting surface preparation.



The cube shape configuration of Type 8688A...T triaxial accelerometer allows for the sensor to be attached to the test surface using any available side with wax, adhesive and/or tape. The off-ground mounting clip can be used in three sensor orientations for mounting flexibility. The primary mounting surface also has a 10-32 UNF threaded hole which is compatible with off-ground screw-on adhesive mounting base accessory in or a magnetic mounting accessory. The frequency response is unaffected for the specified ranges when the adhesive mounting adapter or magnetic mounting adapter is used. When the off-ground mounting clip is used, the upper frequency response without grease is 1 kHz ($\pm 5\%$) for all ranges, 3 kHz ($\pm 5\%$) (with grease for 5 g and 10 g ranges) and 4 kHz ($\pm 5\%$) (with grease for the 50 g range). Reliable and accurate measurements require that the mounting surface be clean and flat. This operating instruction manual provides detailed information regarding mounting surface preparation.



5.2 Preferred Installation Techniques

The preferred mounting technique is dependent on the application. The following is a description of ideal mounting conditions which will provide optimal results for the large variety of mounting features designed into the PiezoBeam product line. As the user becomes familiar with the PiezoBeam, deviations from the ideal situations described, which will not affect the results will, become obvious. As mentioned above, most often Petro Wax is sufficient.

For adhesively mounted units, it is recommended to first connect the cable to the accelerometer and then mount the units to the structure.

5.3 Surface Preparation

PiezoBeam mounting surfaces are flat and perpendicular to the unit's sensitive axis. The mounting surface of the test structure should be flat (flatness <0.001 TIR; roughness 32 μ inch RMS) and perpendicular to the axis of the acceleration forces to be measured. The surface must be free of dirt, moisture, wax or grease residue.

Tapped mounting holes required for the stud mount versions should be perpendicular (<1°) to the mounting surface, free of burrs, and have a perfect thread depth equal to one and a half stud diameters. Class 2B threads are recommended. The accelerometer mounting surface must be in uniform contact with the test structure and not restricted by a tight stud.

5.4 Mounting

5.4.1 Adhesive Mounting

PiezoBeam Accelerometer Types 8640A...T and 8688A..T can be adhesively mounted directly to the test object. For Ground isolated mounting, the sensor can be mounted on thin isolating surfaces (ex. Tape) or use the supplied Accessories. Each accelerometer is supplied with a quick locking adhesive mount clip (Types 8000M156 and 8000M155) and Ground Isolated Adhesive Mounting Base (8000M156 and 8000M155) for Types 8640A...T and 8688A...T respectively. To install the sensors in the clips, use a thin layer of grease between the sensor surface and clip for best frequency response. The sensor is "locked" into place by turning the sensor in the clip until the sensor edges are engaged by the clip. Figures 6 through 9 illustrate the clip mounting. The ground isolated clip is adhesively mounted to the test object. Alternately, the ground isolated adhesive mounting base is screwed into the bottom of each sensor. Pictures of the accelerometers and accessories are shown in Section 5.1.

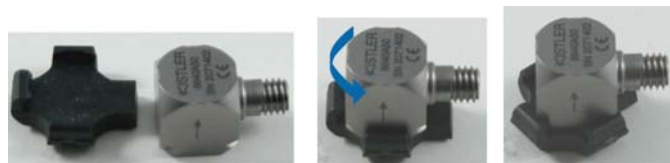

Figure 6: Type 8640A...T with quick locking clip. sensitive axis up



Figure 7: Type 8688A...T with quick locking clip (+Z-Axis up)



Figure 8: Type 8688A...T with quick locking clip (+Y-Axis up)



Figure 9: Type 8688A...T with quick locking clip (-X-Axis up)

The recommended adhesive attachment medium is the supplied Petro Wax (Kistler Type 8432 or P/N P102 from: Katt & Associates; P.O. Box 623 Zoar, Ohio, 44697 USA or equivalent). Wax can be used as it provides repeatable results after the unit has been removed and remounted. A minimal, uniform layer of wax (<0.004", 0.1 mm) should be applied to the test structure's surface and the Sensors/mounting adapters are applied to this layer with firm finger pressure and a alternating twisting motion

The supplied Petro Wax is intended for laboratory type applications where the ambient temperatures are controlled to be near 70 °F (21 °C). A wax which is more pliable at 70 °F (21 °C) is recommended for low temperature applications (Katt & Associates P/N P103 or equivalent). Specially formulated high temperature wax that withstands temperatures up to 225 °F (107 °C) is also available (Katt & Associates P/N P104).

High amplitude inputs, typically in the range of 20 g's rms may dictate the use of a stronger attachment medium. A cyanoacrylate adhesive should be used in these situations (Recommended adhesive is Permabond® 910TM Adhesive; Permabond International, 480 Dean St., NJ 07631 USA, or equivalent). A two component structural adhesive can be used for permanent attached but is not recommended for temporary installation.

**CAUTION!**

Do not, ever, under any circumstances, strike the accelerometer with any object!

Removal of an adhesively mounted unit is accomplished by steadily increasing the torque, from applied finger pressure, to the side of the unit. A wrench, with taped jaws to protect the anodized housing, can be used if absolutely necessary but with extreme care. Refer to Section 6.2.1 for adhesive removal and cleaning procedures.

5.4.2 Stud Mounting, Type 8640A...T

To stud mount Type 8640A...T, a Type 8620, 5-40 stud may be used. In addition, conversion stud Type 8416 (5-40 to 10 32) and Type 8418 (5-40 to M6) are also available. For ground isolated mounting, Type 8400K06, (5-40 to 10-32) and Type 8400K04, 5-40 to M6 are available.

Finger pressure as the torque force provides adequate attachment. A light coating of lubricating grease should be applied to the mating surfaces.

5.4.3 Stud Mounting, Type 8688A...T

To stud mount Type 8688A...T, a Type 8402, 10-32 stud may be used. In addition, conversion stud Type 8416 (5-40 to 10 32) and Type 8411 (10-32 to M6) are also available. For ground isolated stud mounting, Type 8400K01, (10-32 to 10-32), Type 8400K02(10-32 to 6-32) and Type 8400K03 (10-32 to M6) are available.

Finger pressure as the torque force provides adequate attachment. A light coating of lubricating grease should be applied to the mating surfaces.

5.4.4 Magnetic Mounting, Types 8640A...T, 8688A...T

Types 8640A...T and 8688A...T PiezoBeam can be attached using a magnet which screws to the bottom of the sensor. Types 800M160 and 800M159 are recommended for Types 8640A...T and 86898A...T respectively. See section 5.1 for more information. Magnets provide quick, reliable installation on ferrous materials or magnetic materials when exposed to low level inputs. Test structure characteristics (permeability, surface roughness, transverse inputs, etc.) may affect magnetic mounting test results. Every magnetic mounting application should be verified by repeating results obtained from an adhesively attached accelerometer in the same situation until a confidence correlation is achieved. A lubricating grease should be applied to the mating surfaces to achieve the specified coupling force.

5.5 Electrical Installation

As described in section 4.5, the internal charge amplifier requires a source of power. The power source must be of the constant current type

The constant current sources built-in to many FFT analyzers are generally compatible with the PiezoBeam accelerometers. The user should refer to section 4.5.2 for information on compatibility.

Kistler offers a line of couplers that supply power and condition the signal. See the connection diagram in Figure 10 for proper electrical installation. When using triaxial accelerometers, three constant current sources are required per accelerometer.

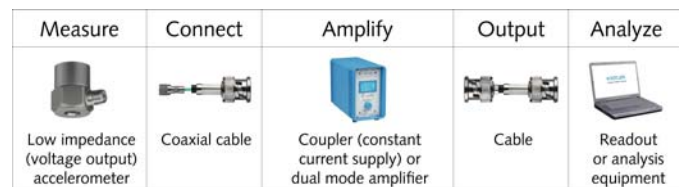

Figure 10: Recommended electrical installation

5.6 Cables

5.6.1 Single Axis Accelerometer Cable Requirements

The low impedance output of the PiezoBeam accelerometers permits using long, coaxial cables. Flexible PVC cables, Types 1768A(X)K01, 1786A(X)K02... provide the sensor mating connector with the cable terminated to a 10-32 or BNC respectively. Alternately, Types 1761B(x) and 1762B(x) provide a Teflon® (Teflon is a registered trademark of DuPont) jacketed cable with the sensor mating connector, terminated to a BNC or 10-32 respectively. Either cabling solution connects directly to any Kistler coupler. Specify the length of the cable when ordering.

5.6.2 Triaxial Accelerometer Cable Requirements

Type 8688A...T triaxial accelerometer uses a ¼-28, 4-pin connector. A flexible silicone jacketed breakout cable, Type 1734A... is suitable for nearly any installation. Type 1734A... provides the mating connector for the sensor and three (X, Y and Z) output BNC positive connectors for connection to a coupler/couplers or data acquisition equipment. Alternately, Teflon® jacketed connecting cable Type 1756B (see Figure 11) provides the mating connector for the sensor and three (X, Y and Z) output BNC positive connectors for connection to a coupler/couplers or data acquisition equipment.



Figure 11: Type 1756B(x) cable connection

An extension cable is available (Type 1578A(X)) that can be connected between the sensor and breakout cable.

Figure 12 shows the cable connections on the triaxial accelerometers. The Figure is looking towards the connector on the accelerometer.

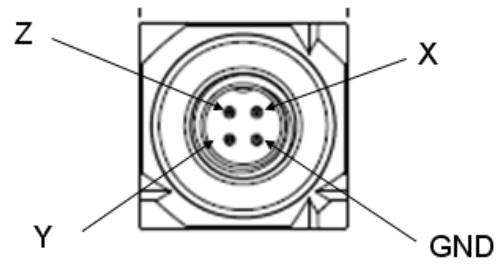

Figure 12: Triaxial accelerometer pin connections (X, Y, Z and Ground) looking into the sensor, Type 8688A...T

5.6.3 Cable Routing

Care should be exercised when routing accelerometer output cables. The cable should be taped close to the accelerometer and to the same surface it is mounted to. This reduces motion between the accelerometer connector and the cable. See Figure 13.

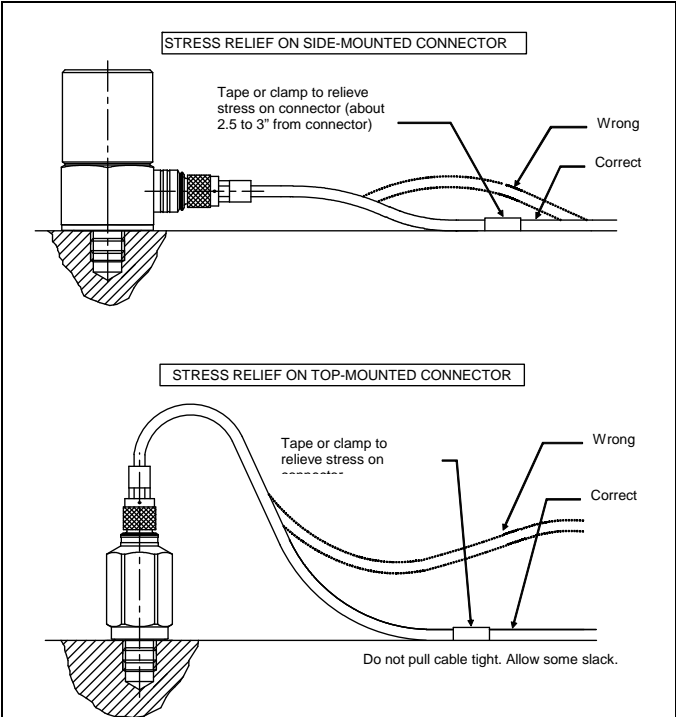

Figure 13: Cable stress relief

6. Calibration and Maintenance

6.1 Calibration

All Kistler sensors are calibrated against standards that are traceable to NIST or PTB. The sensitivity of PiezoBeam accelerometers is standardized to $\pm 5\%$ of their stated sensitivity. Re-calibration may be required if the sensor is subjected to environmental conditions which are significantly beyond the rated limits. Large thermal or mechanical shocks, etc. may create a sensitivity shift or unit failure and it is recommended that the sensor be calibrated after exposure to any excessive environmental conditions.

Calibration certificates delivered with the accelerometers are never older than two (2) years. The PiezoBeam calibration is valid for one (1) year from delivery date.

PiezoBeam accelerometers are produced in a controlled environment under strict process control. The resulting products are extremely reliable and consistent in performance. Extensive product testing has proven that a unit which has proper sensitivity will meet all other stated specifications. It is therefore recommended that an in field confidence check consist of a simple sensitivity check. Type 8921 reference shaker is an ideal instrument to perform a confidence test on the accelerometer as well as the measurement system.

Calibration should be performed once per year to ensure accurate operation. This calibration can be performed by Kistler or using the method described herein.

The user should also check the system integrity using a signal source other than the accelerometer.

Field calibration can be performed accurately and easily using one of the available Kistler back-to-back calibration systems (i.e. Kistler Type 8804A).

6.2 Maintenance

6.2.1 Care and Cleaning

PiezoBeam accelerometers, or any other accelerometer, should not be handled carelessly or dropped. The connector and mounting surface should be kept free of dirt, moisture, wax or grease residue.

The surface of the PiezoBeam accelerometers have a hard anodized coating which is extremely durable, but also brittle. Excessive wax build up on the mounting surface can be rubbed off with paper tissues or lint free, soft rags. The remaining wax can be removed using a degreaser/solvent spray.

Do not scrape the mounting surface with sharp objects (e.g. screw driver, knife blade etc.) as this may damage the hard anodized surface finish.

Excessive cyanoacrylate adhesive (e.g. Permabond 910) can be removed with dimethylformamide or acetone. Refer to the manufacturer's product data for procedures and safety precautions.



CAUTION!

Heed the following while handling accelerometers:

- Do not use ultrasonic agitation
- Keep the connector protection cap in place
- Keep accelerometers in instrument boxes when not in use.

6.2.2 Service and Repair

PiezoBeam accelerometers cannot be repaired in the field. They should be returned to the factory for service, as set forth in the Warranty on the following page.

7. Warranty

The Kistler Group warrants all Kistler products to be free from defects in material and workmanship. All such products are warranted only under normal use and service.

PiezoBeam Accelerometers described herein are warranted for a period of 24 months from date of shipment. For cables and adapters the warranty period is also 24 months.

When returning items under warranty, said equipment shall be returned to Kistler prepaid. Full details relative to the claim of malfunction shall accompany the shipment. No action will be taken until these details are received. Please contact Kistler for a RETURN AUTHORIZATION (RA) number before returning goods.

Settlement will be made at Kistler's discretion, either through repair or replacement of the item in question or through issuance of full credit.

Damage occurring through misuse or mishandling, will not be covered by this warranty.

This warranty is in lieu of all warranties expressed or implied and of all obligations or liabilities on the part of Kistler Instrument Corporation for damages following the use or misuse of items supplied. Any unauthorized disassembly or attempt at repair, shall void this warranty. No agent or representative is authorized to assume for the corporation any liability except as set forth within this warranty document.

Appendix - Technical Information

The Kistler website at www.kistler.com is a helpful source of supplementary information. Technical articles and article reprints provide helpful tutorials and specific application information. The latest versions of most printed sales literature appears on the website.